

BIANCO NXT

pumps

SUMMIT SERIES Vertical Multistage Pump Installation Manual

VMS Solar 10

VMS Solar 15

VMS 10

VMS 15

VMS 20



1. Introduction

Congratulations on your purchase of a BIANCO NXT SUMMIT SERIES Vertical Multistage pump.

Summit Series pumps are a range of high efficiency, non self-priming vertical multistage centrifugal pumps.

With full stainless steel hydraulic parts and high efficiency impellers coupled to a high efficiency motor Summit Series VMS models have a compact footprint and are low noise.

Summit Series VMS pumps are ultra reliable, easy to service and suitable for a wide range of applications.





Suitable for pumping CLEAN, non-aggressive liquids without fibres in a variety of industries and diverse applications.

- Pressure boosting
- Water supply for domestic, industrial, commercial or rural
 - Agriculture, Horticulture, Viticulture – transfer, irrigation, wash down, water treatment
 - Sprinkler/Firefighting, Boiler feed, HVAC, Food and Beverage, Seawater pumping.







2. Contents

1. Introduction	2
2. Contents	2
3. Symbols used in this manual	3
4. Warnings	3
5. Technical Specifications and Materials	4
6. Dimensions	7
7. Hydraulic Performance (optimum efficiency range)	8
8. General Cautions and Advice	9
9. Electrical Connections	9
10. General installation notes	10
11. Intake (suction) piping notes	12
12. Priming, Start Up Checks and Operation	13
13. Pressure Tank Sizing	14
14. Disassembly / Assembly / Servicing	17
16. Warranties – Terms and Conditions	18
17. Trouble Shooting Guide	19

3. Symbols used in this manual

	Warning - Electrical safety
	Warning – Potential consequences of use outside of intended application(s). Includes environmental condition warnings.
	Mandatory warning
	Warning to disconnect power
	Read carefully

4. Warnings

	Read the manual carefully before starting and retain for future reference.
	Prior to starting installation or any maintenance the pump must be disconnected from the power supply and pressure relieved from the system including controller, pump and associated pipework.
	Any changes or modification to the wiring must be carried out by suitably qualified personnel in accordance with all local regulations.
	A qualified electrician should correctly size and install circuit breakers to protect the power supply. The fitment of additional surge protection is recommended.
	Never open the pump terminal box cover while the pump controller is connected to electrical supply.
	This product is not intended for use by persons (including children) with reduced physical, sensory or mental capabilities, or lack of experience and knowledge, unless they have been given supervision or instruction concerning use of the appliance by a person responsible for their safety. Children should be supervised to ensure that they do not play with the appliance.
	To avoid excessive thermal shock to the motor the pump should not start more than 20 times in any one hour period.

5. Technical Specifications and Materials

Motors

- Totally enclosed, fan-cooled, 2-pole standard motors
- Enclosure class: IP55
- Insulation class: F
- Single phase 220 – 240V
- Three phase 280 – 415V
- Solar models Dual voltage: 3 phase 220-240V or 3 phase 380-415V

Liquid temperature °C

- High temperature pump: -15°C to +120 °C

Performance curves

- Measurements taken with motors operating at 2900rpm or 2950 rpm (50 Hz)
- Tolerances to ISO 9906
- Measurements have been made with airless water at a temperature of 20 °C
- The curves apply to the following kinematic viscosity: = 1 mm²/s
- Select the pump model which will operate within the bold section of the pump performance curve and offers the highest efficiency.

Pump operating conditions

- Pumping liquids which are thin, clean, non-flammable, non-combustible or non-explosive, without solid particles or fibres.
- Maximum altitude above sea level: 1000 m
- Maximum ambient temperature: +40 °C

Ambient temperature

If the ambient temperature exceeds the 40 °C or the pump is installed at an altitude exceeding 1000 m, the motor output power P₂ will decrease.

In such cases, it necessary to use a motor with a higher rated output.

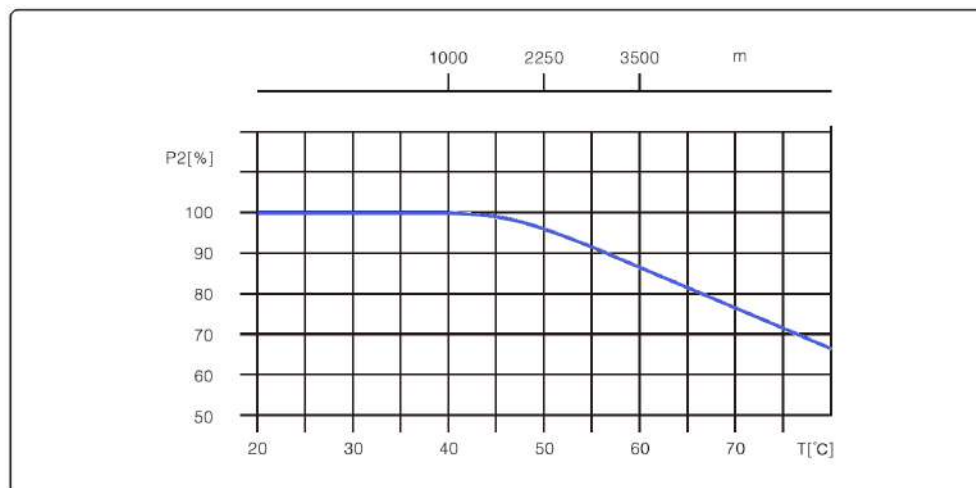

i Cutaway

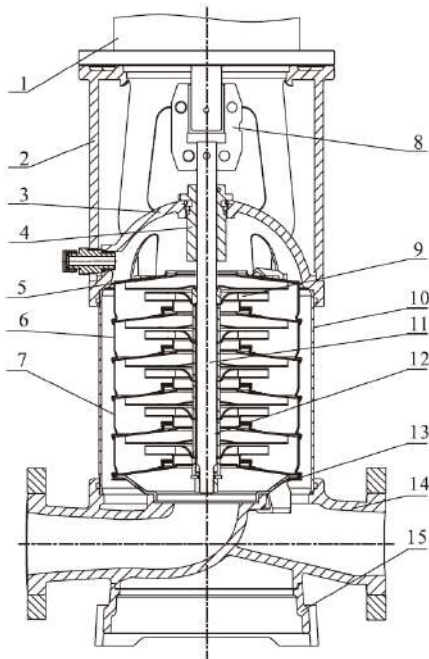

1	Motor	/
2	Bracket	Ductile Cast Iron
3	Seal Base	Stainless / Ductile Cast Iron
4	Mechanical Seal	AS-L-16
5	Top Diffuser	Stainless Steel
6	Diffuser	Stainless Steel
7	Support Diffuser	Stainless Steel
8	Coupling	Stainless Steel
9	Impeller	Stainless Steel
10	Cylinder	Stainless Steel
11	Shaft	Stainless Steel
12	Intermediate Bearing	SIC / WC
13	Inducer	Stainless Steel
14	Inlet/Outlet Chamber	Stainless Steel / Ductile Cast Iron
15	Base	Ductile Cast Iron

ii Avoiding Cavitation

Cavitation may occur if the following conditions exist during pump operation

- The water source is lower than the pump inlet
- High liquid temperature
- Actual flow significantly higher than the rated flow
- Pressure in the pump lower than the vaporisation pressure of the liquid

To avoid cavitation, make sure there is a minimum pressure on the inlet side of the pump. The maximum suction range H(m) can be calculated as follows

$$H = P_b \times 10.2 - NPSH - H_f - H_v - H_s$$

P_b = Atmospheric pressure (atmospheric pressure can be set to 1 bar in a closed system).

P_b is system pressure

H_f = Net positive Suction head

(can be read from the maximum possible flow rate of the pump on the NPSH curve for the individual pump model)

H_f = Pipeline loss at inlet

H_v = Vaporisation pressure

H_s = Safety margin

(Minimum 0.5m head)

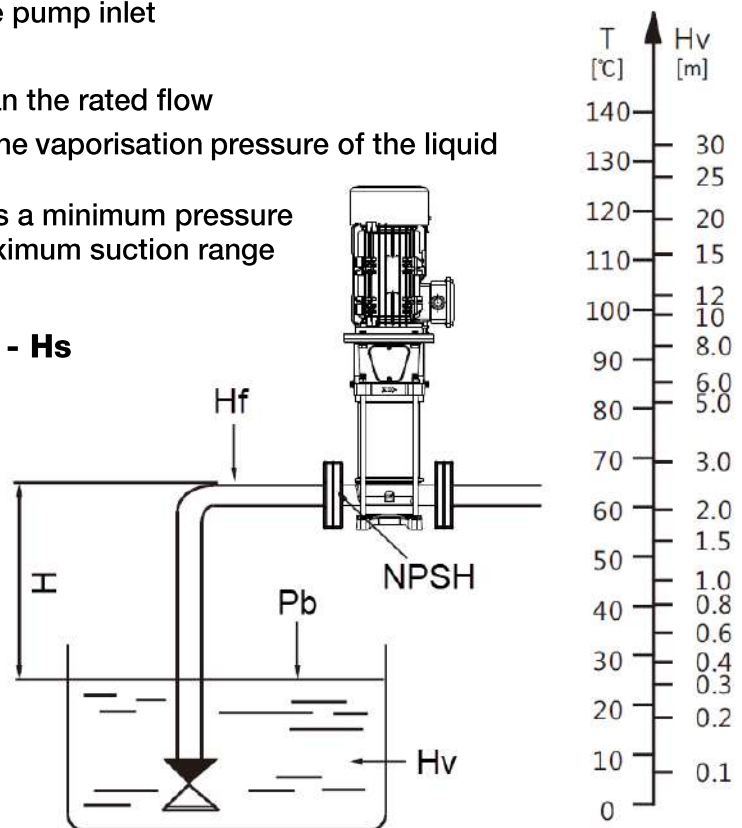

If the calculated value of H is positive, the pump can operate at the maximum suction range H.

If the calculated H is negative, there must be a head with minimum inlet pressure H

iii Performance Summary

	Model	Item Code	P2 Power	Input Voltage	Full Load Current	Cap uF	Max Head	Rated Flow	Optimum range
Three Phase	BIA-NXT-VMS 10/6 M	811917	2.2	1ph 220 - 240V	7.66A	35uF run 200uf start	65	8m3/hr	4.8m3/hr @ 60.3m 10m3/hr @ 50.8m
	BIA-NXT-VMS 10/6 T	811924	2.2	3ph 380 - 415V	4.41A		65	8m3/hr	4.8m3/hr @ 60.3m 10m3/hr @ 50.8m
	BIA-NXT-VMS 10/8 T	811925	3.0	3ph 380 - 415V	5.77A		86.9		4.8m3/hr @ 80.3m 10m3/hr @ 66.9m
	BIA-NXT-VMS 10/10 T	811926	4.0	3ph 380 - 415V	7.56A		113.5		4.8m3/hr @ 105.2m 10m3/hr @ 89.5m
	BIA-NXT-VMS 10/12 T	811927	4.0	3ph 380 - 415V	7.56A		129.8		4.8m3/hr @ 119.9m 10m3/hr @ 102.1m
	BIA-NXT-VMS 10/14 T	811928	5.5	3ph 380 - 415V	11.8A		161.8		4.8m3/hr @ 150.1m 10m3/hr @ 127.7m
	BIA-NXT-VMS 15/5 T	811929	5.5	3ph 380 - 415V	11.8A		91		15m3/hr
	BIA-NXT-VMS 15/6 T	811930	7.5	3ph 380 - 415V	13.86A		108.1	9m3/hr @ 102.8m 18.8m3/hr @ 90.7m	
	BIA-NXT-VMS 15/8 T	811931	11.0	3ph 380 - 415V	19.84A		143.6	9m3/hr @ 137.1m 18.8m3/hr @ 120.5m	
	BIA-NXT-VMS 20/4 T	811932	5.5	3ph 380 - 415V	11.8A		69.5	20m3/hr	12m3/hr @ 65.6m 25m3/hr @ 50.2m
BIA-NXT-VMS 20/5 T	811933	7.5	3ph 380 - 415V	13.86A		91.2	12m3/hr @ 87.9m 25m3/hr @ 71.3m		
Solar	BIA-NXT-VMS-SOLAR 10/20	811934	0.75	3ph 220 - 240V Δ 3ph 380 - 415V Λ	2.94A 1.68A		22.1	10m3/hr	6.0m3/hr @ 17.3m 12.5m3/hr @ 7.5m
	BIA-NXT-VMS-SOLAR 15/10	811935	1.1	3ph 220 - 240V Δ 3ph 380 - 415V Λ	4.2A 2.31A				13.5

Model	Item Code	Max pressure	Max Inlet Pressure	Outlet	Mech Seal	Weight
BIA-NXT-VMS 10/6 M	811917	33 bar	26.6	PN25-40/DN40 Dia 50mm	AS-L-12	34kg
BIA-NXT-VMS 10/6 T	811924	33 bar	26.6	PN25-40/DN40 Dia 50mm	AS-L-12	38.3kg
BIA-NXT-VMS 10/8 T	811925		24.5			
BIA-NXT-VMS 10/10 T	811926		21.9			
BIA-NXT-VMS 10/12 T	811927		20.3		AS-L-16	60.5kg
BIA-NXT-VMS 10/14 T	811928		17.1			
BIA-NXT-VMS 15/5 T	811929		22.1			
BIA-NXT-VMS 15/6 T	811930	31 bar	20.4	PN25-40/DN50 Dia 50mm	AS-L-16	83.6kg
BIA-NXT-VMS 15/8 T	811931		16.9			
BIA-NXT-VMS 20/4 T	811932		25 bar			
BIA-NXT-VMS 20/5 T	811933	16.1				
BIA-NXT-VMS-SOLAR 10/20	811934	34 bar	31.8	PN25-40/DN50	AS-L-12	34.5kg
BIA-NXT-VMS-SOLAR 15/10	811935	31 bar	29.7		Dia 65mm	AS-L-16

6. Dimensions

Model		A	B	C	H	~	F
		Motor Height	Motor Dia	Motor Radius	Wetend Height	Total Height	Flange Spacing
BIA-NXT-VMS10/6	811917	272	166	135	425	697	280
BIA-NXT-VMS 10/6T	811924	272	166	135	425	697	
BIA-NXT-VMS 10/8T	811925	339	193	147	495	834	
BIA-NXT-VMS 10/10T	811926	354	220	172	525	879	
BIA-NXT-VMS 10/12T	811927	354	220	172	555	909	
BIA-NXT-VMS 10/14T	811928	414	259	192	635	1049	
BIA-NXT-VMS 15/5T	811929	414	259	192	566	980	300
BIA-NXT-VMS 15/6T	811930	414	259	192	611	1025	
BIA-NXT-VMS 15/8T	811931	523	311	235	790	1313	
BIA-NXT-VMS 20/4T	811932	414	259	192	521	935	300
BIA-NXT-VMS 20/5T	811933	414	259	192	566	980	
BIA-NXT-VMS-SOLAR 10/20	811934	271	154	124	355	626	280
BIA-NXT-VMS-SOLAR 15/10	811935	271	154	124	346	617	300

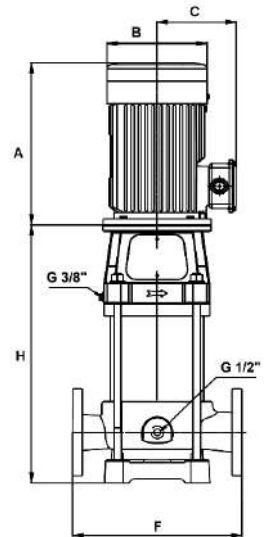

BIA-NXT-VMS-SOLAR 10-20	811934
BIA-NXT-VMS 10/6 M	811917
BIA-NXT-VMS 10/6 T	811924
BIA-NXT-VMS 10/8 T	811925
BIA-NXT-VMS 10/10 T	811926
BIA-NXT-VMS 10/12 T	811927
BIA-NXT-VMS 10/14 T	811928

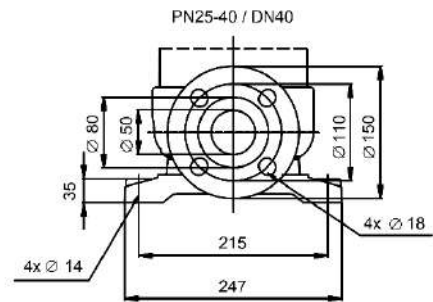
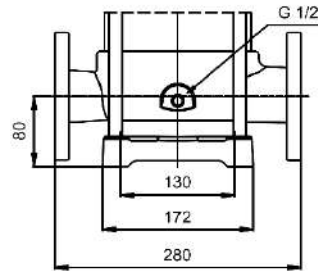

BIA-NXT-VMS 15/5 T	811914
BIA-NXT-VMS 15/6 T	811915
BIA-NXT-VMS 15/8 T	811916
BIA-NXT-VMS 20/4 T	811921
BIA-NXT-VMS 20/5 T	811922
BIA-NXT-VMS-SOLAR 15-10	811935

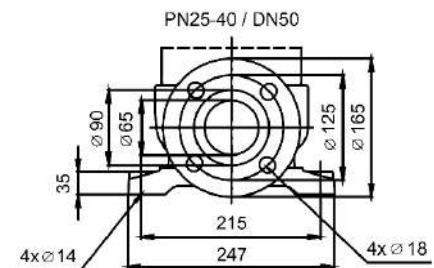
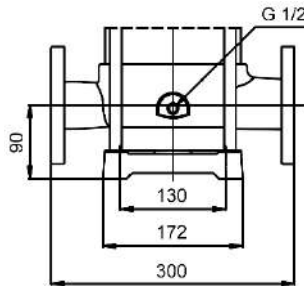

Example: wet-end nameplate

SUMMIT SERIES				Bianco NXT		
Vertical multistage centrifugal pump						
MODEL	BIA-VMS*/**M or T	Q MAX	** m ³ /h	N	2950 r/min	CE
CODE	*****	H MAX	***m	F	50 Hz	 MANUAL
S/N	*****	P	** kW	TMAX.	120 °C	

The motor has a separate nameplate with rated voltage and current

7. Hydraulic Performance (optimum efficiency range)

In continuous operation, best pump reliability, efficiency and longevity will be achieved with the pump operating between 50 – 130% of the pump rated flow. Detailed data sheets including hydraulic performance curves are available on the whiteint.com.au or whiteint.co.nz websites

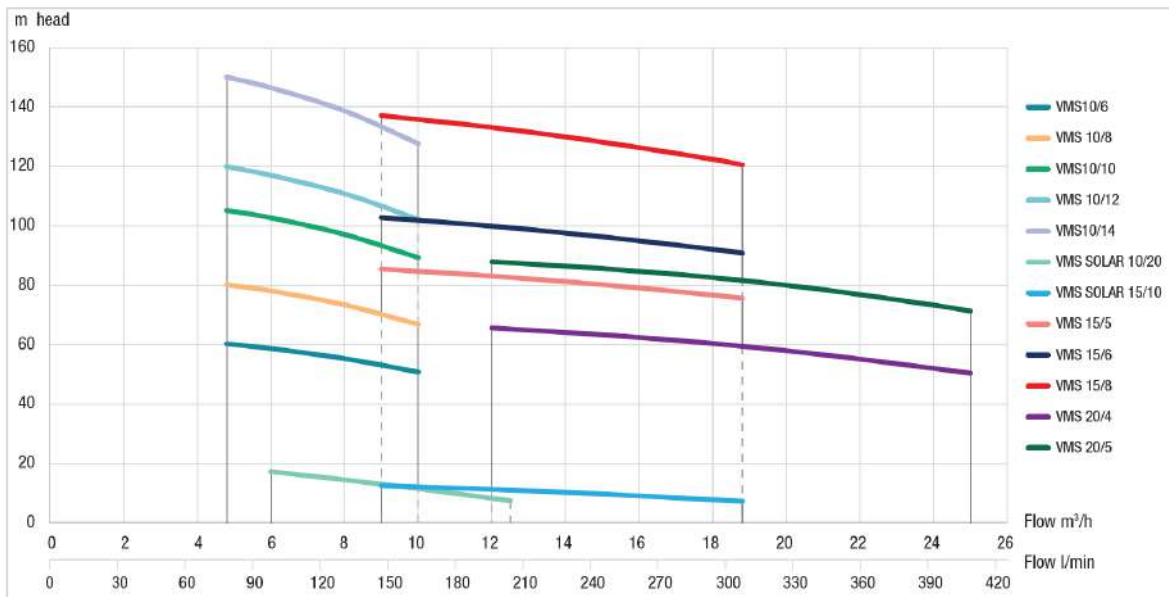
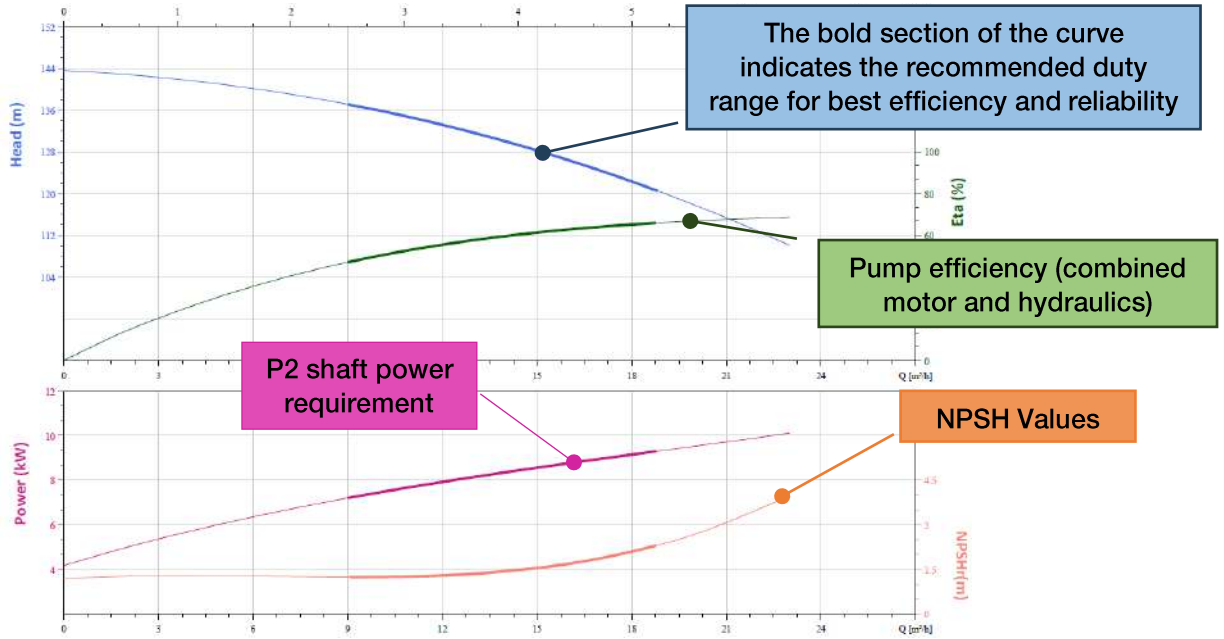

8. General Cautions and Advice

Fitment, servicing and replacement must be carried out by competent, skilled and qualified personnel.

Running the pump without water or allowing the pump to run dry will damage the mechanical seal, voiding the warranty.

Pumps and control devices installed in locations susceptible to insect infestation should ensure there is pest control plan in place.

The pump is designed for use with clean water. Contamination including sand or mineral deposits may affect the operation of the pump and shorten its life expectancy.

Protect the pump and any control devices from rain and moisture and minimise exposure to extremes of heat and cold. The technical specifications include the recommended air and water temperatures.

Avoid situations where the pump could be exposed to corrosive liquids or gasses, or to flammable materials, solvents etc.

Ensure the maximum pump pressure and maximum inlet pressure values are respected.

Maximum pump starts not to exceed 30/hr evenly spaced up to 3kW motor power. 3kW and greater 20 starts per hour evenly spaced.

If the pump is starting and stopping excessively check the system for leaks or residual low demand. Fitting a suitably sized and rated pressure accumulator will reduce pump cycling. See Section 13

9. Electrical Connections

Always use an electrical outlet that is protected by Residual Current Device (RCD) Safety Switch with a trip current of 30mA or less. A Safety switch is required by Australian/New Zealand Standard AU/NZS 60335.1-20



Refer to the motor data plate for electrical information (frequency, voltage, nominal current).

All motors must be protected by a circuit-breaker or contactor with overload set to the current marked on the motor data plate.



Ensure an isolating switch is fitted which complies with local standards.

It is strongly recommended to fit protective device(s) which protect against voltage fluctuations, running outside of reasonable current variances and in the case of 3 phase motors, provide loss of phase protection



The pump motors can be connected to a soft starter or variable frequency drive.

The drive must not generate a peak change of voltage dV/dt more than 500 V/ms as this will cause noise and potentially damage the motor windings. In cases approaching or exceeding this guideline value, place an IC (inductance-capacitance) filter between the drive and the motor

SOLAR VMS three phase motors can be configured 3Ph 415V or 3Ph 240V

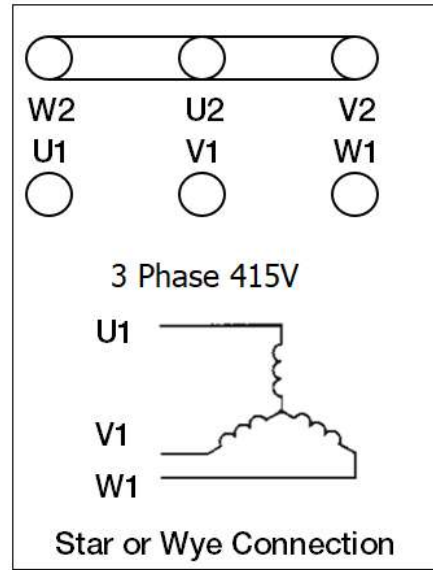
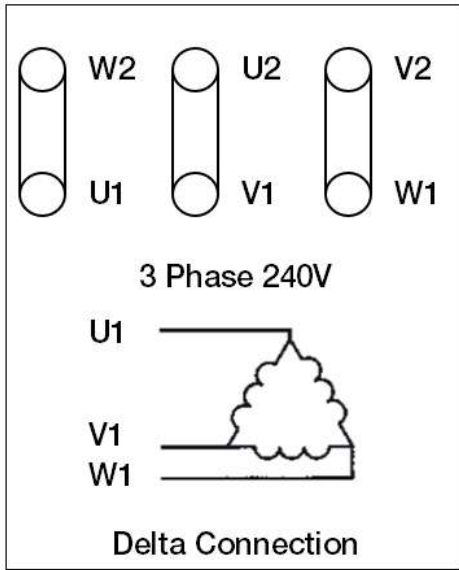

ENSURE THE PUMP IS WELL EARTHED

10. General installation notes

Handle the pump carefully avoiding shock loading or knocks which could alter the alignment of the pump hydraulic assembly.

Before installation, inspect the pump for any shipping damage. Remove protective inserts from pump ports before fixing.

It is possible to remove the bolts securing the motor and rotate to re-position the terminal box. Care must be exercised to ensure the pump alignment is maintained.

Choose a pump location with a firm base as close to your water source as possible and close to a suitable power supply.

The pump should be housed in a weatherproof, free draining, well vented location to protect it from the extremes of temperature, moisture, flooding, chemicals, vermin and insects, dust etc.

Allow a minimum of 150mm around the pump to ensure effective cooling.

Arrows on the inlet/outlet casting indicate the direction of flow.

Ensure the pump is mounted with pump motor uppermost and bolted down securely, preferably on a concrete base.

Reinforced rubber or other suitable material(s) can be installed under the pump footing to reduce noise transference. Care must be taken that the pump is installed plumb to the vertical.

Avoid strain on the pump casing by supporting your pipework.



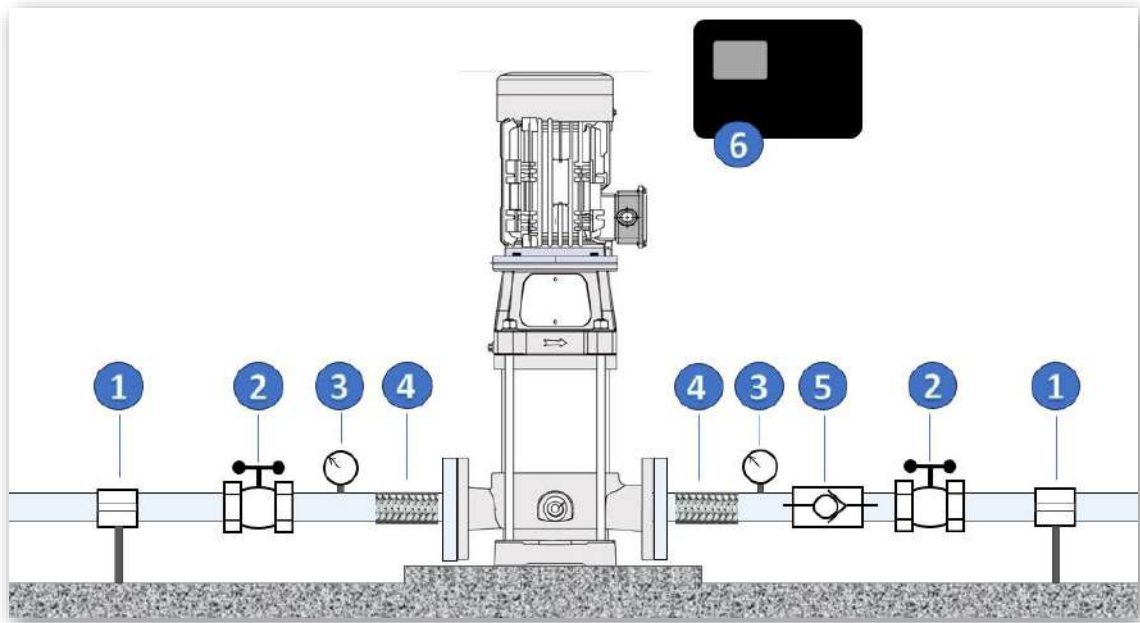

- 1 Pipe Support: Support all piping well to avoid stress on the connections.
- 2 Isolation Valves: Fit isolation valves prior to the inlet and after the pump discharge to enable the pump to be isolated or removed for servicing.
- 3 Gauges: (compound on the inlet, pressure on the discharge) provide valuable insights into pump operation.
- 4 Flexible piping: fitted on the inlet and outlet sides of the pump reduce vibration and noise.
- 5 Non-return check valve: prevents return flow of pumped liquid whenever the pump is stopped, reducing the danger of pump damage.
- 6 Control panel: conforming with local standards and regulations.

- 7 If it is necessary to alter the pipe size, use eccentric reducers. Ensure the suction pipe has a positive gradient to prevent the formation of air pockets.
- 8 Use long radius bends to minimise suction pipe friction losses.
- 9 Fit a non-return type foot valve and ensure it is located so it will always remain submerged and will not draw air.

Check the NPSH curves and system design to ensure the pump is selected correctly.

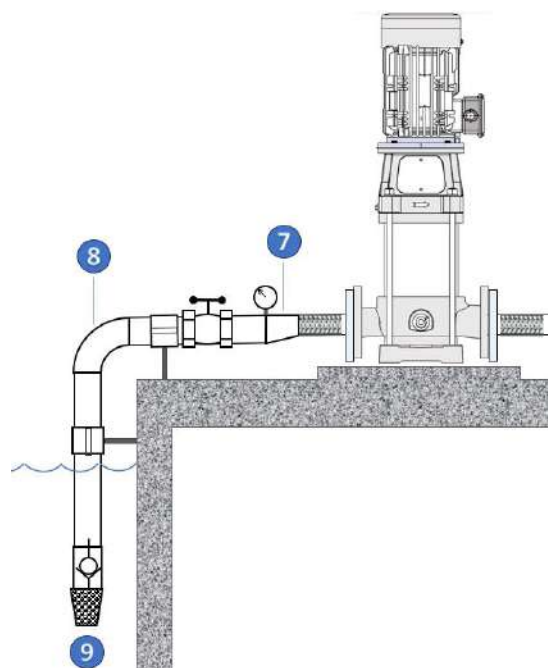

11. Intake (suction) piping notes



The intake suction piping is the most critical part of any installation. Errors or leaks will cause significant issues for performance and pump reliability.

Hydraulic connections

- The diameter of the suction piping must **never** be less than the pump inlet.
- The inlet pipe must be a short and straight as practical.
- Avoid features such as unnecessary tapers or bends as they create head losses.
- The suction pipe must be fully airtight under negative pressure.
- The suction line should rise continuously from the water source to the pump in order to avoid vapor locks.

Reminders of best practice:

Inlet pipe size must be equal to or larger than the inlet port size.

Note that intake pipes which are too small, too long or must lift significantly result in a substantial reduction from the pump rated duty.

If the suction line is quite long fit an isolating valve close by the pump.

A non-return valve in the suction line is recommended.

Avoid bends within [5 x pipe diameter] of the inlet port.

Avoid pipework which results in air pockets.

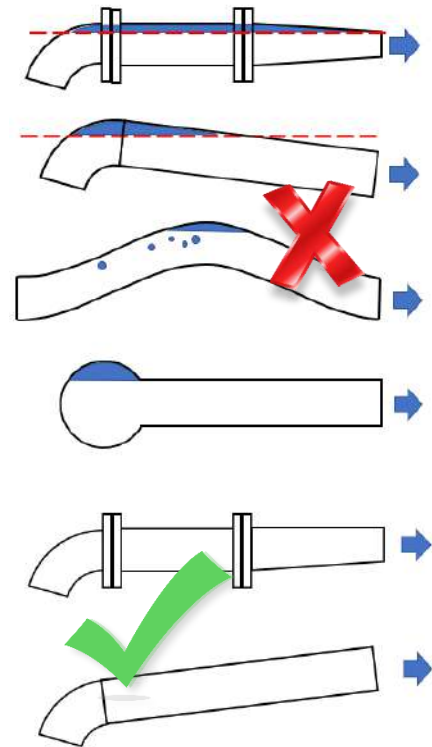

Pumps operate more efficiently with positive suction.

Multistage pumps generate suction lift but lack self-priming ability.

Where a pump is installed with a suction lift, ensure the suction line is kept as short as possible and the pipe diameter is at least one size larger than the pump inlet.

Every care must be taken in suction lift situations that the pump does not lose prime.

Consult the pump data sheet for the pump NPSH performance

12. Priming, Start Up Checks and Operation

Protection against dry running

Ensure a suitable device is fitted to prevent dry running and protect against loss of prime occurrences.

Pump Priming

Flooded suction installations

- Close the discharge valve.
- Unscrew the bleed plug **A** fitted to pump head.
- Gradually open the valve on the suction line and allow the pump to fill completely.
- Once water is flowing out freely, and all air has been eliminated, screw the bleed plug back in. **A**



Pump with suction lift – check the pump data sheet for the NPSH curve.

- Close the discharge valve.
- Open the suction valve (if fitted).
- Remove the prime / bleed plug **A** on the main body of the pump.
- Unscrew the bottom drain / priming plug **B** on the pump casing four or five turns.
- Put a funnel into the bleed plug and slowly and completely fill the pump and the suction pipe.
- Screw the bleed plug and the bottom drain and priming plug back in. **A B**

Check direction of rotation

Remove one of the shaft coupling protective covers. With the power disconnected, turn the coupling by hand to make sure that it turns freely. Refit the cover



Start the motor briefly.



The direction of rotation is indicated by the arrow on the pump head. Viewed from above and looking down at the motor fan, the shaft movement should be anti-clockwise.

Note that a pump running in reverse will pump liquid, but the performance will be nowhere close to the design expectation.

Post Priming

- Unscrew the prime plug **A** and top up the water in the pump.
- If necessary, repeat this operation until all air is expelled from the pump.

Initial Start Up

The pump must not be operated in a no-flow condition (discharge valve closed) for more than 5 minutes with cold water.

- To avoid the formation of a gas-pocket at the top of the pump, a minimum flow around 10% of the rated capacity of the pump is recommended.
- A pressure gauge will enable you to assess the stability of the discharge pressure.
- When discharge pressures are unstable, bleed the pump again or repeat the priming operation.
- Check that the current draw does not exceed the value marked on the motor data plate.

Servicing

No special servicing is required in normal operation.

To improve motor cooling and efficiency, keep the pump clean of dust, cobwebs etc. especially the motor and fan cover.



For a prolonged shutdown, where there is a risk of freezing, empty the pump by removing the drain plug and the air bleed plug.

Motors with grease fittings

If the motor is fitted with grease nipples, the motor should be lubricated with a high temperature lithium-based greases every 5000hrs. Motors without grease nipples do not require regular maintenance.

Mechanical seal

The mechanical seal needs no servicing in operation.

The mechanical seal must never be allowed to operate dry.

13. Pressure Tank Sizing



The primary purpose of a pressure tank is to reduce the frequency of pump starts.

A secondary benefit is protection against water hammer effects. In addition, a pressure tank reduces noise and needless power consumption, saving energy (and therefore running costs) while extending the life expectancy of the pump.

Many systems have small residual draw-offs and supplying the top-up water from a pressure tank will result in significant energy savings. Over its lifetime, a pressure tank will pay for itself many times.

By storing a volume of water against a gas 'spring', a supply of pressurized water is available to satisfy small draws offs.

A properly sized pressure tank is essential in systems controlled by pressure switches (DOL start)

For pumps and pump-sets controlled by VFDs, pressure tanks assist with smoother operation of the pump-set and perform an important function in maintaining flow/pressure in fast reacting systems

Tank sizing – DOL starting

To select the correct sized pressure tank, it is necessary to first know the following

- System flow rate,
- Pump performance,
- Pump pressure settings, specifically the cut out pressure.
- **Desired drawdown** to provide sufficient water between pump cycles

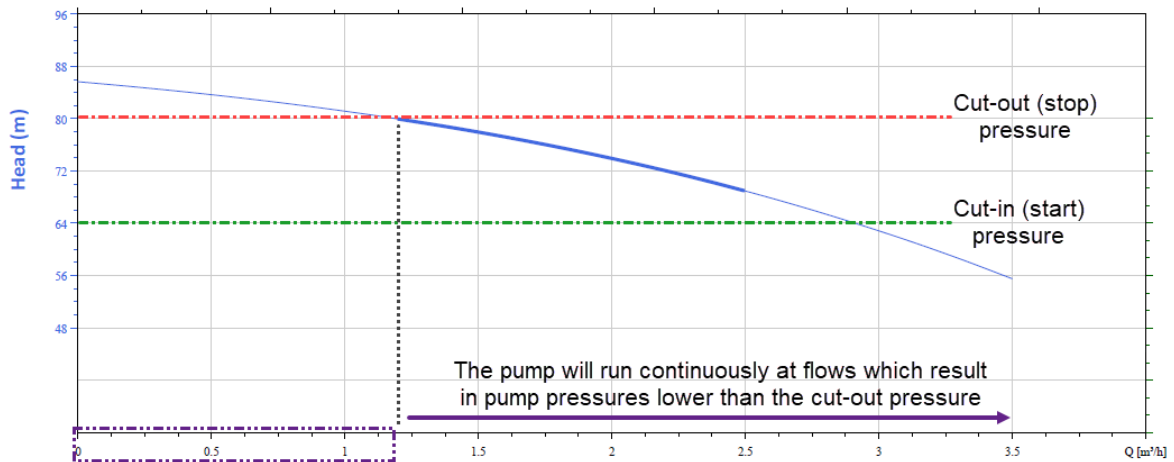

(Lower) flows resulting in pump pressures higher than the cut-out pressure will result in pump cycling

Note that a pressure tank with its gas pre-charge set correctly should never accept more water than 1/3 of the total tank volume

Once the amount of water needed to prevent pump cycling is established, select a pressure tank 3 times larger. *Note: This assumes 2 bar differential between cut-out and cut-in*

i.e. Desired drawdown = 30 litres. Multiply by 3 = 90 litres. 100 litre pressure tank required

Pressure tank pre-charge

Pressure tank pre-charge must never be lower than 2/3 of the maximum system pressure

Should the calculated value be significantly less than the cut-in pressure, set the pre-charge 20kpa lower than the pump start pressure

		CUT IN PRESSURE							
		1.5	2.0	2.5	3.0	3.5	4.0	4.5	5.0
CUT OUT PRESSURE	2.5	1.30	1.80	Green cells - precharge is 20kpa below cut in pressure					
	3.0	1.66	1.80	2.30	Blue cells - pre-charge is 66.6% of cut out pressure				
	3.5	2	1.80	2.30	2.80				
	4.0	2.33	2.33	2.33	2.80	3.30			
	4.5	2.66	2.66	2.66	2.80	3.30	3.80		
	5.0	3	3	3	2.80	3.30	3.80	4.30	
	5.5	3.33	3.33	3.33	3.33	3.30	3.80	4.30	4.80
	6.0			3.66	3.66	3.66	3.80	4.30	4.80
	6.5			4	4	4	4	4.30	4.80
	7.0			4.33	4.33	4.33	4.33	4.33	4.80
8.0			4.99	4.99	4.99	4.99	4.99	4.99	
9.0				5.66	5.66	5.66	5.66	5.66	

Tank pre-charge greater than 5 bar

Where the system pressure requires pre charge pressure greater than 5 bar the following procedure must be followed to prevent damage to the diaphragm

1. Set the gas pre-charge of the tank to 5 bar
2. Install the tank into the system.
3. Fill the system with water to equalise both system and pre-charge pressure at 5 bar
4. Add additional gas pre-charge pressure towards the desired total in steps not exceeding 3 bar per step
5. Should the maximum 3 bar (per step) gas pressure be reached, add additional system water to equalise both system and pre-charge pressures .
6. Repeat steps 3 to 5 until the desired pre-charge is reached.

Emptying a tank that has a pre-charge over 5 bar,

1. Ensure there is some water in the tank.
2. Isolate the tank from the system (close isolation valve) ensuring no additional water can get into the tank (shut off the pump and / or any water supply).
3. Release air from tank until 3 bar (44 psi) tank / air pressure is remaining.
4. Open a drain valve and afterwards the isolation valve to drain the tank.



CAUTION: Make sure that the system pressure is never lower than 5 bar below pre-charge. If system pressure needs to be lowered, the tank should be isolated or emptied as previously described

Tank sizing – Variable Frequency Drives

Typically, 18 – 25 litre pressure tanks, or 80 – 100 litre pressure tanks are used on pumps and pump-sets controlled by variable frequency drives operating at constant pressure.

There are many circumstances, due to the hydraulic nature of the installation, where a greater drawdown volume is required. Every situation is unique but the following provides a means to calculate the correct tank size.

In cases where the system can rapidly change to full flow, the variable frequency drive will have a minimum response time. Typically, this time is approx. 10 seconds for a single pump 1 and then 12 seconds for each subsequent pump.

Assuming the connected pipework can handle the sudden change in velocity, a larger pressure tank (or tanks) may be necessary to buffer the response time.

In this case the pressure tank drawdown and therefore minimum sizing should be calculated using Boyles law as illustrated below:

EXAMPLE

Say the maximum predicted sudden change from sleep mode is to a flow rate of 5 l/s.

Assuming a single pump can handle the increase in flow, the minimum response time for this pump is 10 seconds.

Therefore, the draw off to cover the pump response time would be $10 \times 2.5 \text{ l/s} = 25 \text{ litres}$
Thus we need the pressure tank to cover that demand until the pump can respond.

The formula to determine pressure tank size requirement is:

$$V = \frac{(P_{pc}+100) \times C}{P_{ci}+100} - \frac{(P_{pc}+100) \times C}{P_{co}+100} \quad \text{where}$$

- V = draw off required to cover pump response time C **25 litres (2.5 l/sec for 10 seconds)**
- P_{pc} = the pressure tank charge pressure in kPa **396 kPa (66% of max system pressure)**
- P_{ci} = the nominated Wake Up pressure in kPa **400 kPa**
- P_{co} = the Setpoint in kPa **600 kPa**

Therefore: $25 = \frac{(396+100) \times C}{(400+100)} - \frac{(396+100) \times C}{(600+100)}$

$$25 = \frac{496C}{500} - \frac{496C}{700}$$

$$25 = 0.992C - 0.708C$$

$$25 = 0.284C$$

Required tank capacity C = 25 litres / 0.284 = 88 litres.

Best practice is to round up to next available size i.e. 100 litre tank

Note that calculation makes no allowance for the take up flow from the pump(s) during the ramp up period

14. Disassembly / Assembly / Servicing

There are no specific service requirements outside of ensuring the pump motor (fan and cooling fins) remain clean to aid cooling.

Images of pump parts and assembly / disassembly information is available from White International on request

Mechanical Seal	Model	Appearance
	AS - L - 16	

16. Warranties – Terms and Conditions

This warranty is given in addition to the consumer guarantees found within the Australian Competition and Consumer Act 2010 (Cth) for goods purchased in Australia and the Consumer Guarantees Act 1993 NZ for goods purchased in New Zealand:

1) White International Pty Ltd / White International NZ Ltd (White International) warrant that all products distributed are free from defects in workmanship and materials, for their provided warranty period as indicated on the top or opposite side of this document. Subject to the conditions of the warranty, White International will repair any defective products free of charge at the premises of our authorised service agents throughout Australia and New Zealand if a defect in the product appears during the warranty period. If you believe that you have purchased a defective product and wish to make a claim under this warranty, contact us on our Sales Hotline on 1300 783 601, or send your claim to our postal address or fax line below and we will advise you as to how next to proceed. You will be required to supply a copy of your proof of purchase to make a claim under this warranty.

2) This warranty excludes transportation costs to and from White International or its appointed service agents and excludes defects due to non-compliance with installation instructions, neglect or misuse, inadequate protection against the elements, low voltage or use or operation for purposes other than those for which they were designed. For further information regarding the suitability of your intended application contact us on our Sales Hotline on 1300 783 601. If you make an invalid claim under this warranty, the original product will be sent back to you unrepai red.

3) This warranty refers only to products sold after the 1st January 2012, and is not transferable to another product type and only applies to the original owner, purchaser or end user, and is in addition to the consumer guarantees found within the Competition and Consumer Act 2010 (Cth) for goods purchased in Australia and the Consumer Guarantees Act 1993 (NZ) for goods purchased in New Zealand.

4) Our goods come with guarantees that cannot be excluded under the Australian Consumer Law. You are entitled to a replacement or refund for a major failure and for compensation for any other reasonably foreseeable loss or damage. You are also entitled to have the goods repaired or replaced if the goods fail to be of acceptable quality and the failure does not amount to a major failure. 2 YEAR WARRANTY

5) To the fullest extent permitted by law, White International excludes its liability for all other conditions or warranties which would or might otherwise be implied at law. To the fullest extent permitted by law, White International's liability under this warranty and any other conditions, guarantees or warranties at law that cannot be excluded, including those in the Competition and Consumer Act 2010 (Cth), is expressly limited to: (a) in the case of products, the replacement of the product or the supply of equivalent product, the payment of the cost of replacing the product or of acquiring an equivalent product or the repair of the product or payment of the cost of having the product repaired, is at the discretion of White International or a 3rd party tribunal elected under the Competition and Consumer Act 2010 (Cth) for goods purchased in Australia and the Consumer Guarantees Act 1993 (NZ) for goods purchased in New Zealand; and

6) To the fullest extent permitted by law, this warranty supersedes all other warranties attached to the product or its packaging.

7) In the case of services, supplying the services again or the payment of the cost of having the services supplied again, is at the discretion of White International or a 3rd party tribunal elected under the Competition and Consumer Act 2010 (Cth) for goods purchased in Australia and the Consumer Guarantees Act 1993 (NZ) for goods purchased in New Zealand. 8) Our warranty commences from the date of purchase of the above-mentioned pumps. Proof of purchase is required before consideration under warranty is given.

Record your date of purchase in the space below and retain this copy for your records.

Date of Purchase**Model Purchased**

17. Trouble Shooting Guide

	POSSIBLE CAUSE	POTENTIAL SOLUTIONS
The pump won't start and makes no noise	<ol style="list-style-type: none"> 1. No electricity (power supply issue) 2. Fuses or RCD tripped 3. Internal motor fault 4. The static head pressure is greater than the cut in setting (applies when commissioning) 5. Controller has sensed dry run and is protecting the pump 6. Motor overloaded. 7. Motor starter failure. 8. Control circuit is defective. 	<ol style="list-style-type: none"> 1. Check the power supply. Is the power LED on the controller illuminated? 2. Fuses or RCD tripped may indicate more serious problems 3. Check the motor 4. Static water head above the controller must be less than cut in pressure 5. Check the pump protection/control 6. Check pump system. 7. Replace starter. 8. Replace control circuit.
Motor protective circuit breaker trips immediately when supply is switched on	<ol style="list-style-type: none"> 1. Fuses or RCD tripped 2. Contacts in motor-protective circuit breaker are faulty. 3. Cable connection is loose or faulty. 4. Motor winding is defective. 5. Pump mechanically blocked. 6. Motor-protective circuit breaker setting is too low. 7. Start / run capacitors are faulty. 	<ol style="list-style-type: none"> 1. Replace fuses. 2. Check or replace starter. 3. Check cables or power supply. 4. Replace motor. 5. Check and clean impurities. 6. Reset motor-protective circuit breaker. 7. Check capacitors on single phase models. <ul style="list-style-type: none"> • Refer to VFD control manual. • Replace start/run capacitors.
Motor-protective circuit breaker trips out occasionally.	<ol style="list-style-type: none"> 1. Motor-protective circuit breaker setting is too low. 2. Power supply failed periodically. 3. Low voltage at peak times. 	<ol style="list-style-type: none"> 1. Set the motor-protective circuit breaker correctly. 2. Check power supply. 3. Add voltage stable device
Motor-protective circuit breaker has not tripped out but the pump does not run.	<ol style="list-style-type: none"> 1. Contacts in motor-protective circuit breaker are faulty. 2. Control circuit is defective. 	<ol style="list-style-type: none"> 1. Check or replace motor protective circuit breaker. 2. Replace control circuit.
The pump runs but there is no flow or only poor flow	<ol style="list-style-type: none"> 1. Valves closed 2. Air entering suction line (loss of prime) 3. The water level may be too low 4. Pump may be worn or damaged 5. Blockages in the pump, suction or discharge 6. Suction pipe/pump blocked by impurities. 7. Foot or non-return valve blocked in closed position. 8. The piping may be too long or too small 	<ol style="list-style-type: none"> 1. Check suction and discharge isolating valves 2. Check for leaks and ensure all joins or fittings are sealed. Re-prime, vent air. 3. Check water availability 4. Check and service 5. Check and service 6. Clean the suction pipe/pump. 7. Repair the foot or non-return valve. 8. Review the piping design.

17a. Trouble shooting guide cont.

	POSSIBLE CAUSE	POTENTIAL SOLUTIONS
The pump runs. There is flow but poor pressure	<ol style="list-style-type: none"> Excessive flow demand Total head requirement too great for the pump – output flow and pressure poor Pump may be worn or damaged Air entering suction line reducing performance 	<ol style="list-style-type: none"> Check that the pump selected is correct for the application Check the pump specification Service or replace Ensure the suction line is sealed correctly
Pump performance not constant.	<ol style="list-style-type: none"> Pump inlet pressure is too low (cavitation). Suction pipe/pump partly blocked by impurities. Pump drawing in air. Pump rotation direction wrong 	<ol style="list-style-type: none"> Check the suction conditions. Clean the suction pipe/pump. Check the suction conditions. Bleed air from system. Change the motor running direction.
Pump cycling on and off	<ol style="list-style-type: none"> Small water draw off or leak Leak in suction or discharge line 	<ol style="list-style-type: none"> Check for small leaks Check for leaks including suction line non return valve
Pump runs intermittently	<ol style="list-style-type: none"> Overheating and thermal protection tripping 	<ol style="list-style-type: none"> Ensure the water temp is less than 40°C Ensure sufficient airflow to cool the motor. <i>Note that low voltage can cause the motor to overheat.</i>
Pump vibrates and is noisy Abnormal vibration or noise.	<ol style="list-style-type: none"> Incorrectly mounted/fixed Internal blockage causing impeller imbalance If the flow requirement is greater than the pump is capable of it will cavitate. <i>Cavitation sounds like gravel inside pump.</i> Leakage in suction pipe Suction pipe is too small or partly blocked by impurities. Air in suction pipe or pump. Pump mechanically blocked. Motor bearing failure. Stack height incorrect 	<ol style="list-style-type: none"> Ensure the pump is solidly attached to a base Remove the blockage Reduce the water demand to see if the noise disappears. <ul style="list-style-type: none"> Ensure the suction pipe is sized correctly A different pump model may be required Repair the suction pipe Install larger suction pipe or clean the suction pipe. Re-prime, vent air. Repair pump. Replace motor bearings. Adjust stack height
Water leaking from the centre of the pump	<ol style="list-style-type: none"> The mechanical seal is leaking 	<ol style="list-style-type: none"> Replace the mechanical seal



www.whiteint.com.au

www.whiteint.co.nz

Please always refer to our website for further technical information & new product innovations

Disclaimer: Every effort has been made to publish the correct information in this manual.
No responsibility will be taken for errors, omissions or changes in product specifications.

© 2024 Copyright White International Pty Ltd

TM ® - WARNING: Please be aware that various brands & products depicted within this document are subject to trademark, patent or design registrations. Infringement of any intellectual property contained within this document without express written authority by the appropriate intellectual property holder may result in further legal action to be taken. For any queries regarding use of the contained information please feel free to contact White International Pty Ltd.